

Standard Strike

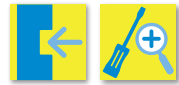

Standard strike is a fixed type.

Material: Stainless, Steel

Standard Strike	
Product No	Finish/Color
227-010	Hairline
Screw included:	
3.5×20 Flat head tapping screw 2pcs	

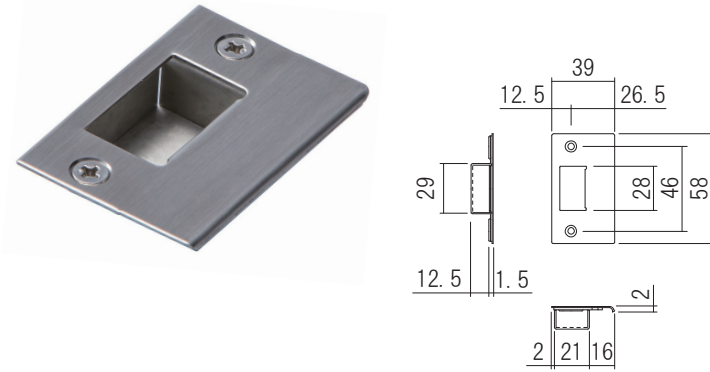

Adjustable Strike

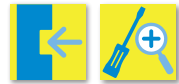

The depth of the strike can be easily adjusted using a screwdriver without losing the fixed screws.

Material: Stainless, Steel, Resin
Finish/Color: Barrel Polishing
Adjustment Range: Front-Back ±2mm

Adjustable Strike		
Product No	Specification	Function
227-011	F Type	
227-012		Small door
227-013	P Type	
227-014		Small door

Screw included:
(F Type)
3.5×20 Flat head tapping screw 2pcs
(P Type)
3.5×22 Flat head wood screw 2pcs

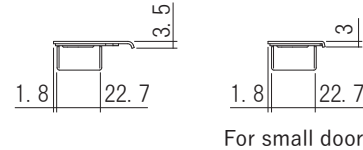
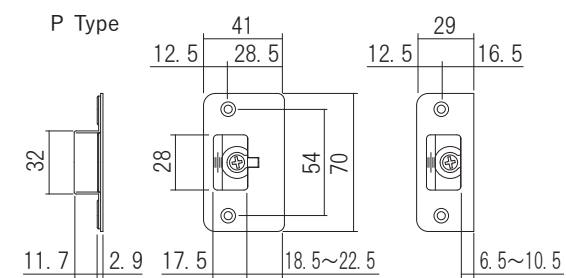
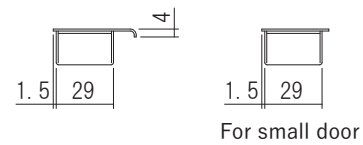
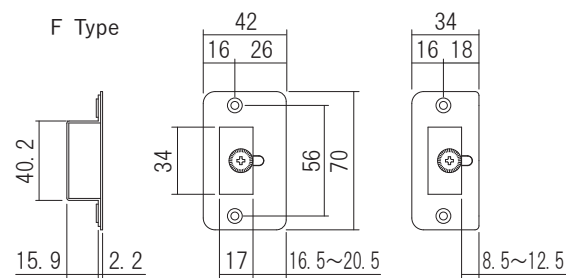

FL Lock Case Cutaway View

■ Appropriate door thickness 28 ~ 36 mm

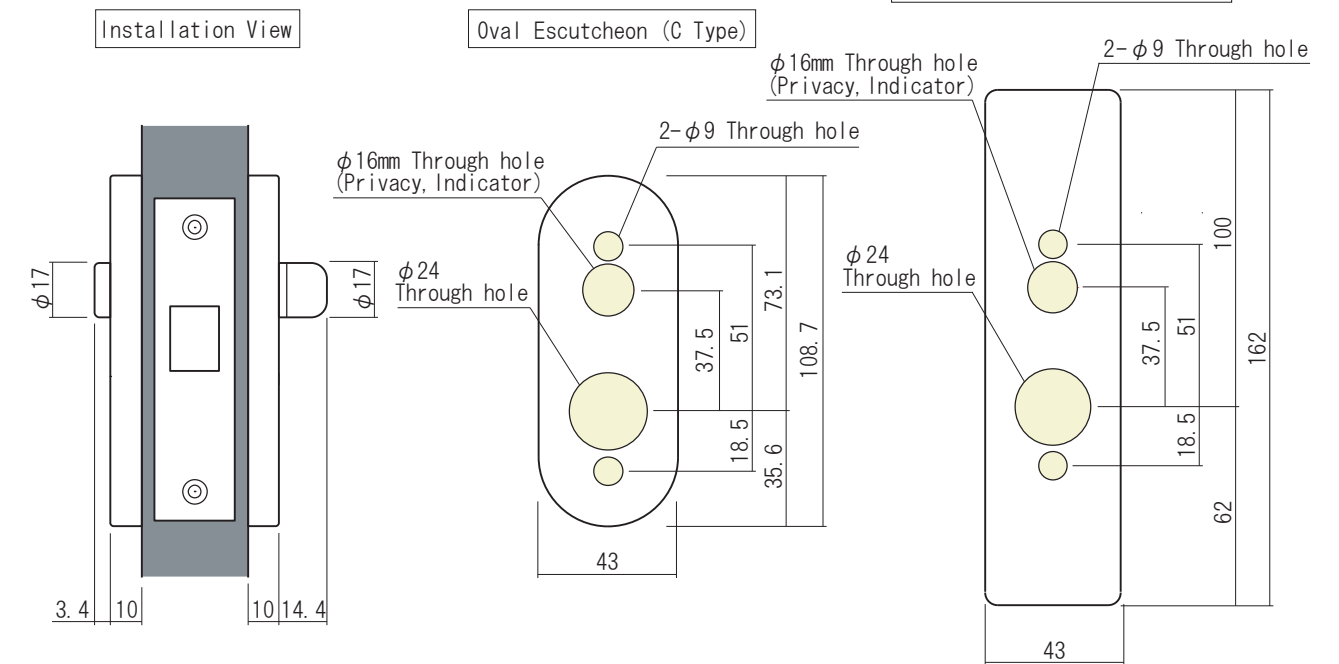
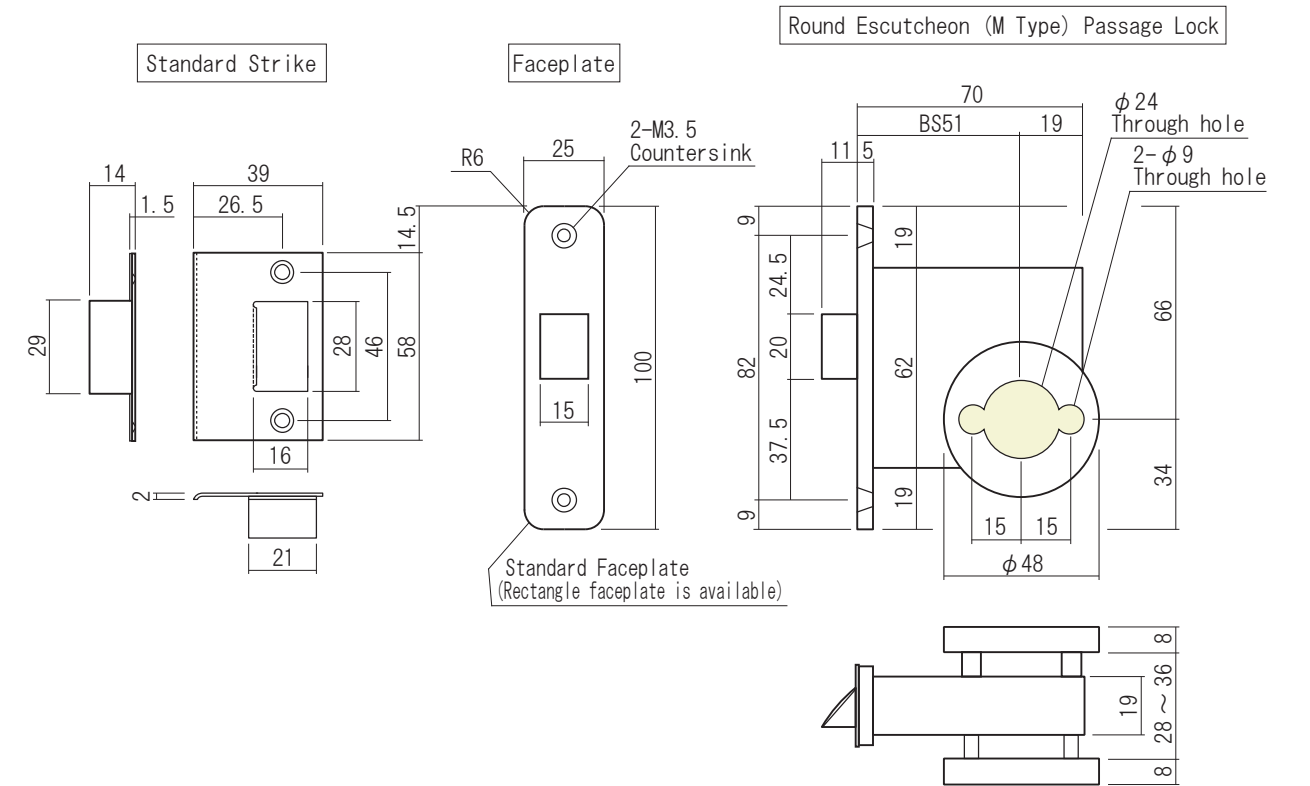

...Shows the cut out part.