

Handle

There are variants of pulls with different designs and colors for cabinet doors or drawers that you can choose to suit the space in your room.



D Type Handle

Material: ZDC
Door Thickness: 25~29mm

| D Type Handle | | |
|---------------|---------------|--------------|
| Product No. | P: length(mm) | Finish/Color |
| 222212 | 100 | Amber |

Screw included:
M4 × 35 Truss head machine screw 2pcs

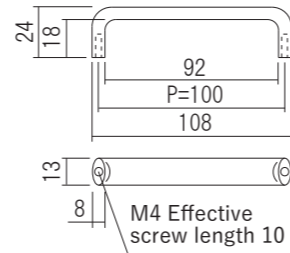

TKC Handle

Material: ZDC
Door Thickness: 19~24mm

| TKC Handle | | |
|-------------|---------------|----------------|
| Product No. | P: length(mm) | Finish/Color |
| 223120HS | 120 | Satin Silver |
| 223120CR | | Chrome Plating |

Screw included:
M4 × 30 Truss head machine screw 2pcs

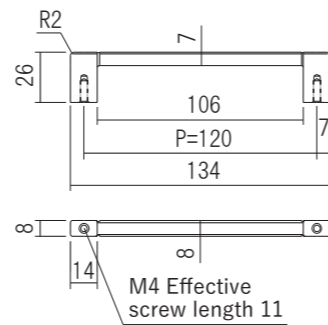
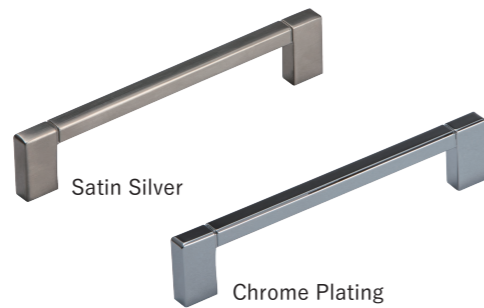

ND Handle

Material: ZDC
Door Thickness: 13~14mm

| ND Handle | | |
|-------------|---------------|--------------|
| Product No. | P: length(mm) | Finish/Color |
| 222232 | 100 | Satin Silver |
| 222242 | | Satin Gold |

Screw included:
M4 × 20 Truss head machine screw 2pcs

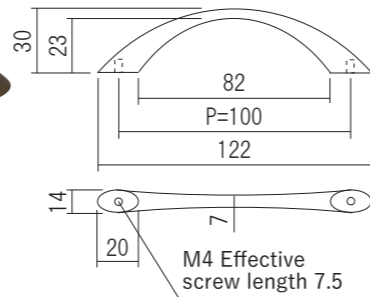

SUS Handle

Material: Stainless
Door Thickness: 20~24mm

| SUS Handle | | |
|-------------|---------------|--------------|
| Product No. | P: length(mm) | Finish/Color |
| 226011 | 85 | Raw Material |
| 226012 | | Black |

Screw included:
M4 × 30 Truss head machine screw 2pcs

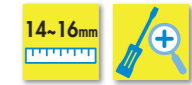
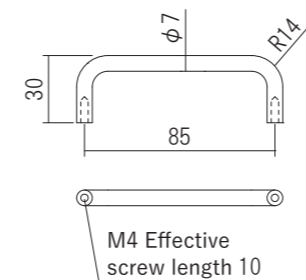
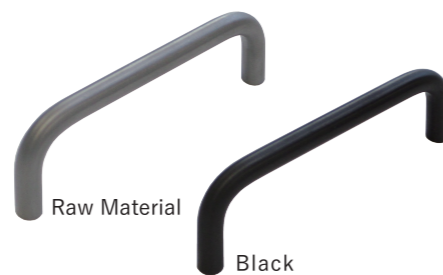

RK Handle

This Cabinet handle has a stylish design and easy to grip. It can be installed in a wide range of cabinets from living room, kitchen, and restroom.

Material: ADC
Door Thickness: 14~16mm

| RK Handle | | |
|-------------|---------------|--------------|
| Product No. | P: length(mm) | Finish/Color |
| 226035 | 35 | Satin Silver |
| 226060 | 60 | |
| 226120 | 120 | |

Screw included:
M4 × 22 Truss head machine screw 2pcs

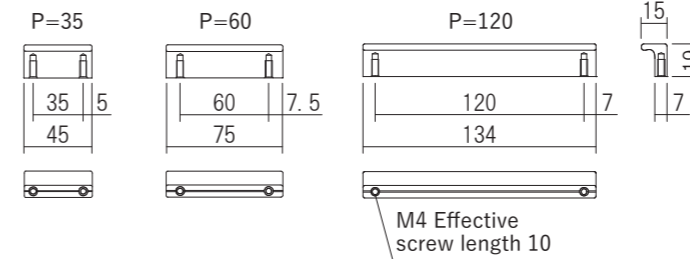
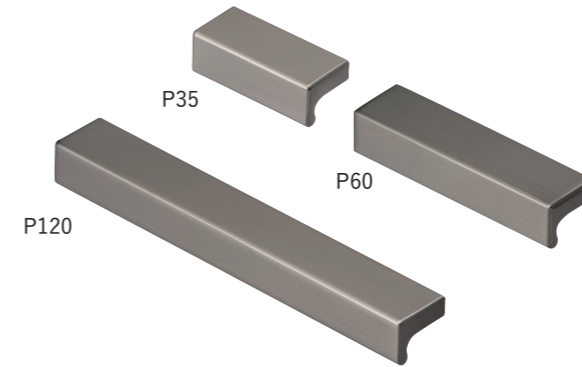

CA Handle

A Cabinet and kitchen handle that made of Stainless. The hairline finish is harmonized with the door.

Material: Stainless
Door Thickness: 18~24mm

| CA Handle | | |
|-------------|---------------|--------------|
| Product No. | P: length(mm) | Finish/Color |
| 224020 | 150 | Hairline |
| 224021 | 300 | |
| 224022 | 600 | |

Screw included:
M4 × 30 Truss head machine screw 2pcs
※ There is a possibility of bending depend on the usage of P=600.

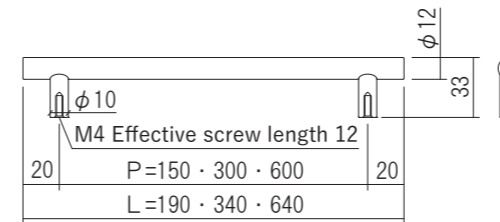
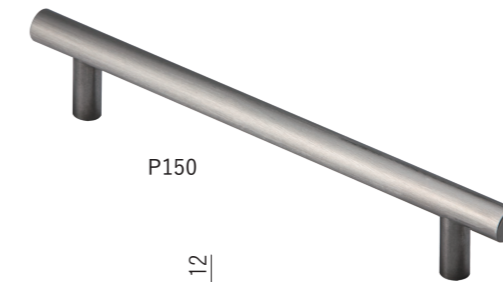

MJ Handle

A storage and kitchen handle with a simple design. We made it with a clean design to fit various kinds of storage.

Material: Aluminum
Door Thickness: 18~24mm

| MJ Handle | | |
|-------------|---------------|----------------|
| Product No. | P: length(mm) | Finish/Color |
| 224001 | 200 | Alumite Silver |
| 224002 | 220 | |
| 224007 | 230 | |
| 224004 | 450 | |

Screw included:
M4 × 30 Truss head machine screw 2pcs
※ There is a possibility of bending depend on the usage of P=450.

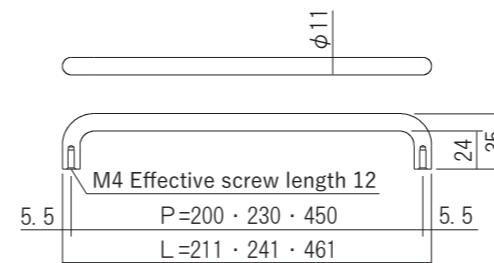

Lever Handles

Door Parts

Sliding Door Parts

Accessories

Cabinet Parts · Handrail

Euro Series

Aftermarket Parts